

Frese SIGMA Compact

DN15-DN50

- DK **Montagevejledning**
- DE **Montageanleitung**
- EN **Mounting instructions**
- ES **Instrucciones de montaje**

Danmark · Tlf. +45 58 56 00 00
 Deutschland · Tel. +49 (0)241 475 82 333
 UK · Tel. +44 (0)1704 896012

FIG 1

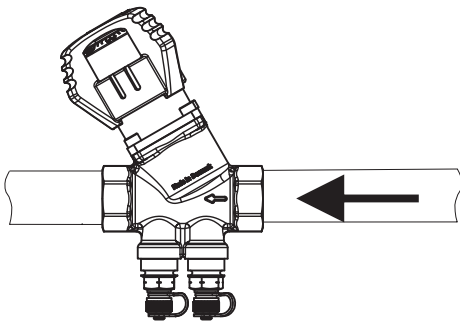

Frese SIGMA Compact DN15 - DN50

FIG 2

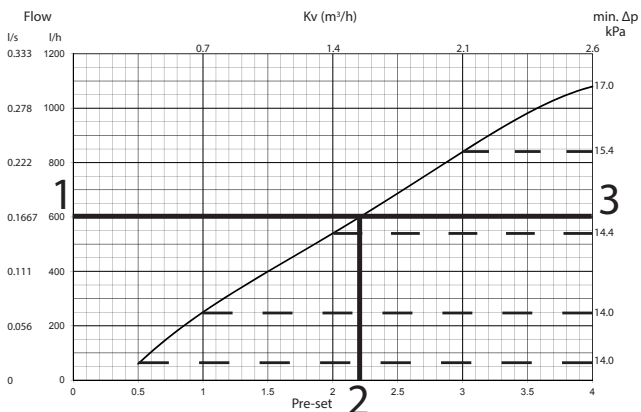

Frese SIGMA Compact flow rate graph - DN 15 Low

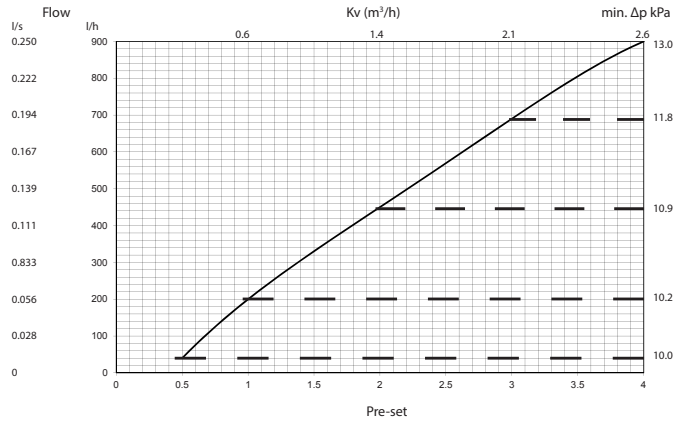

Frese SIGMA Compact flow rate graph - DN 15 High

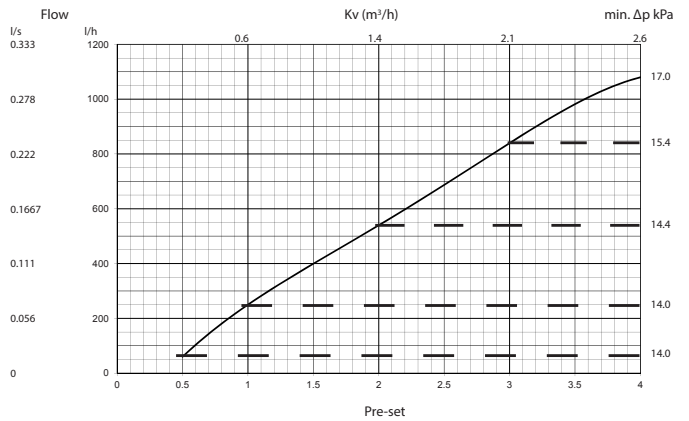

Frese SIGMA Compact flow rate graph - DN 20 Low

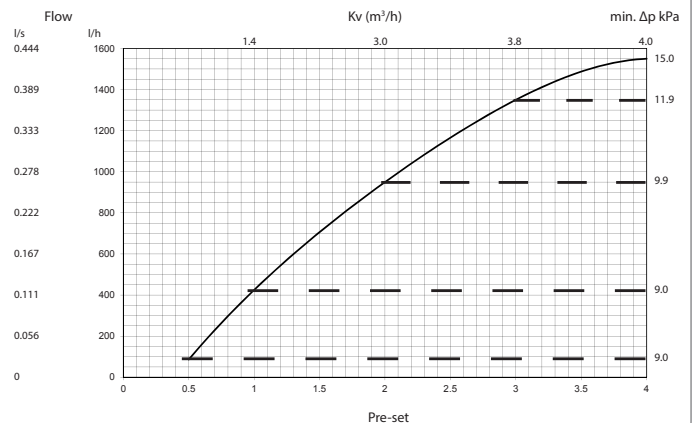

Frese SIGMA Compact flow rate graph - DN 20 High

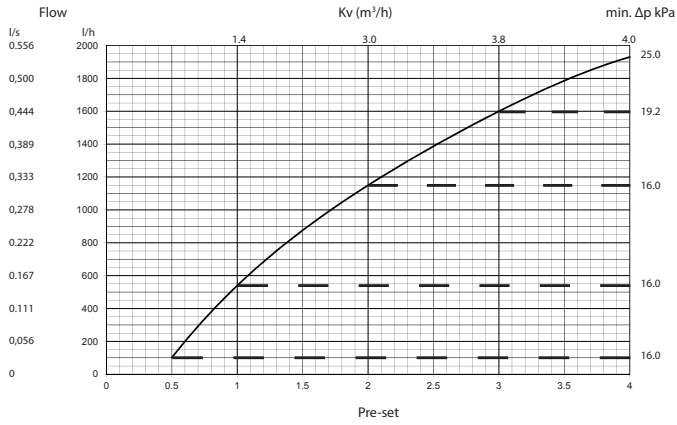

Frese SIGMA Compact flow rate graph - DN 32

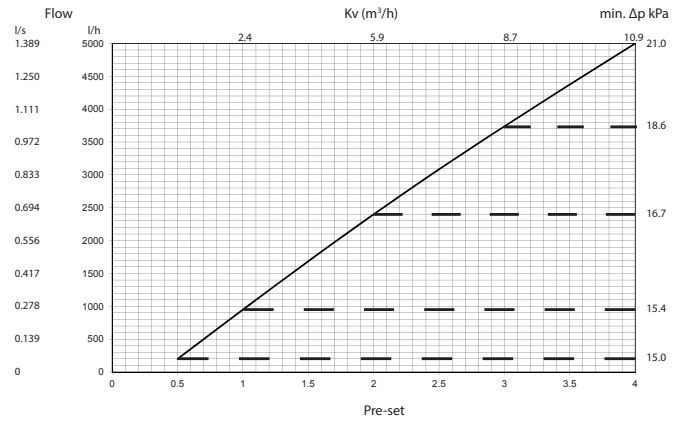

Frese SIGMA Compact flow rate graph - DN 25 Low

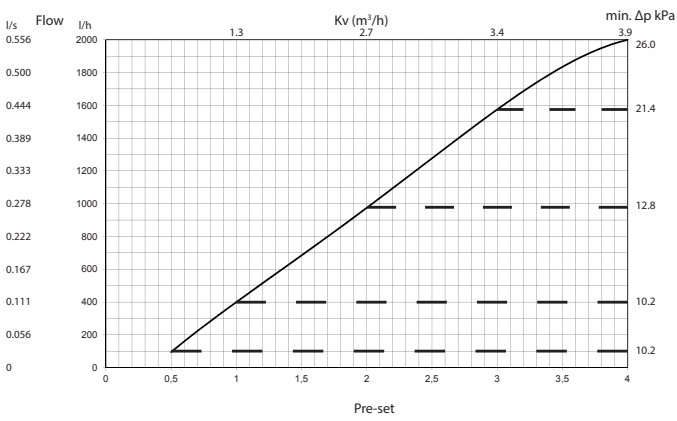

Frese SIGMA Compact flow rate graph - DN 40

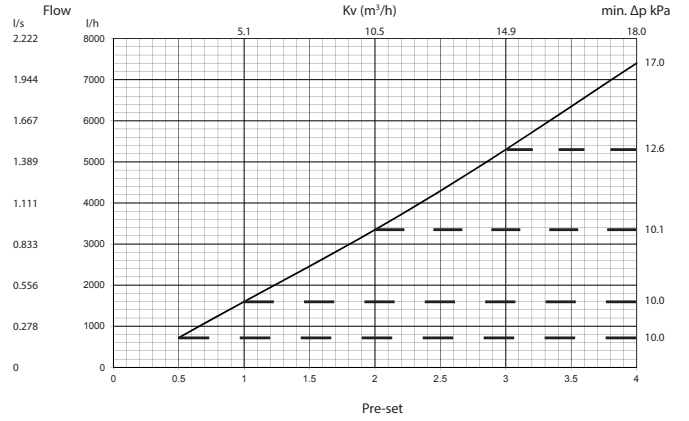

Frese SIGMA Compact flow rate graph - DN 25 High

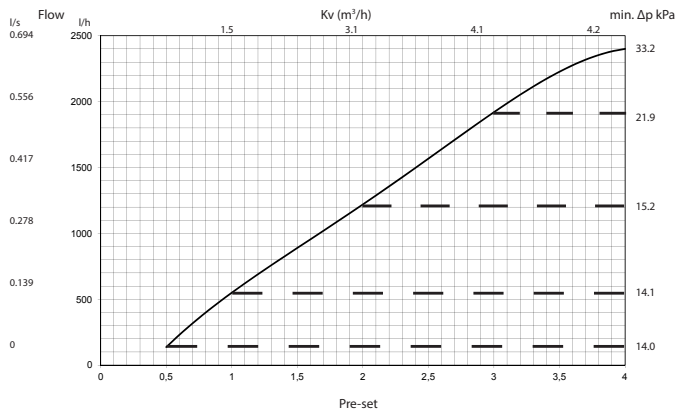

Frese SIGMA Compact flow rate graph - DN 50

